

Rhino Metals
 Outswing Door
 80" H x 40" W
Minimum Rough Opening
 80 3/8" H x 40 5/8" W
Maximum Rough Opening for Clamshell Installation
 83" H x 46" W
Maximum Rough Opening for Concrete Anchor Installation
 81" H x 41 1/4" W
Minimum Wall Thickness
 8"
Standard Hardware Maximum Wall Thickness
 8.5"

Rhino Metals vault doors come with 2in bolts. For greater wall thicknesses, refer to the custom bolts ordering reference table in these instructions below the tools and materials section. Rhino Metals concealment panels to hide visible wall framing when the vault door is opened may also be purchased for vault doors with thicker walls than 8.5". If used, concealment panels must be attached **before** the vault door is installed.

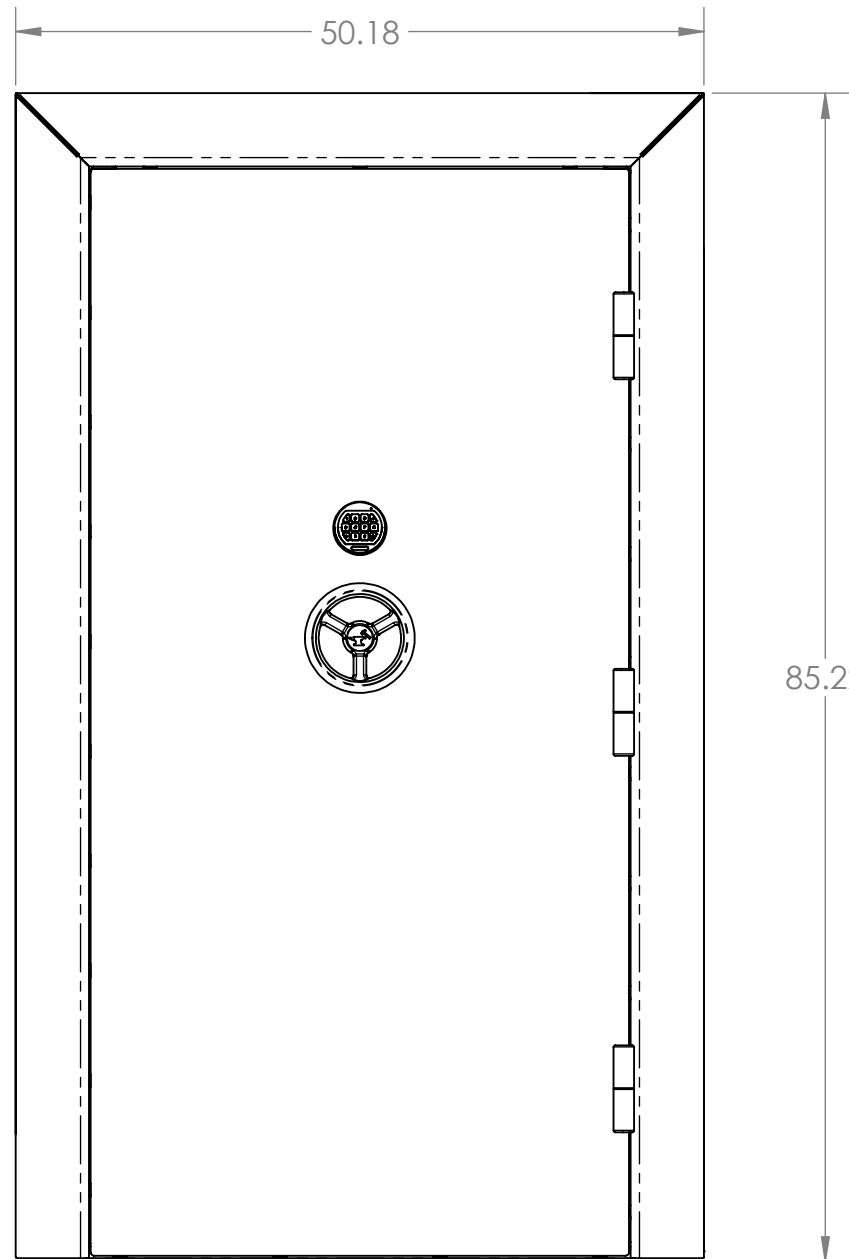

SCALE 1 : 14

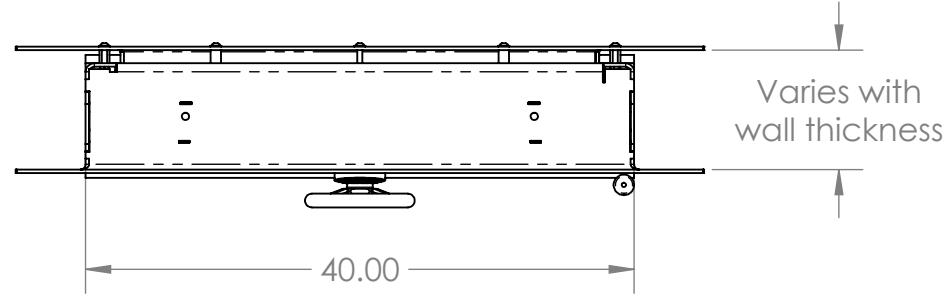
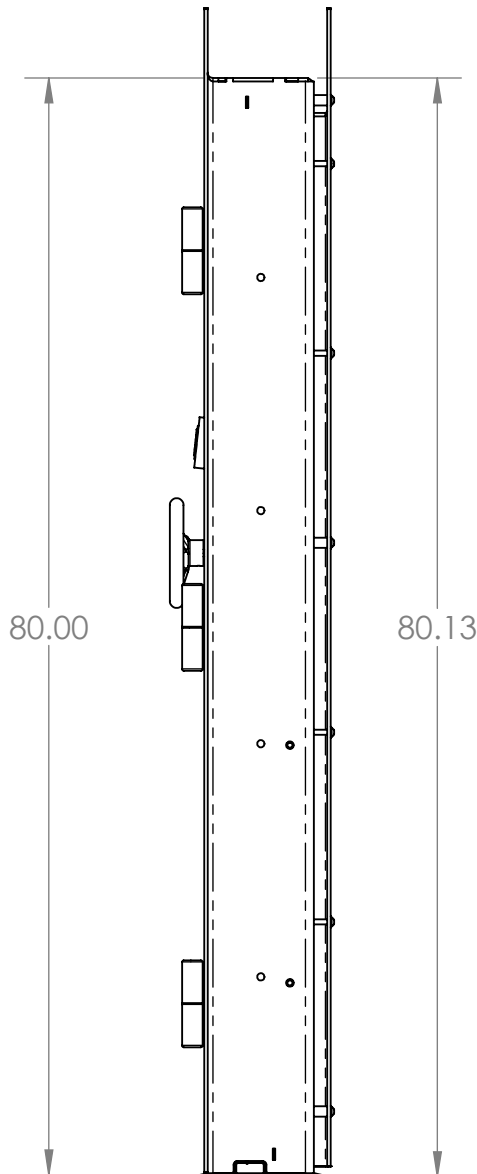

Before attempting install, please review all the installation instructions on the following pages. A minimum of two people are required for install, but four people are recommended (two on both the install room's inside and outside).

Clamshell Installation (see page 2)

Standard installation procedure that involves using the vault door's back and front frame pieces to clamp against the wall.

Tools and Materials Needed for Clamshell Installation:

1. Allen wrench: 7/32"
2. Wrench: 9/16"
3. Level
4. Shim shingles
5. Small pry bar (optional)
6. 3M brand high temperature silicone sealant

Concrete Anchor Installation (see page 3)

Optional procedure that involves anchoring the vault door into a concrete wall for additional security. The concrete anchor installation procedure can either be done in addition to the clamshell installation procedure or instead of the clamshell installation procedure for very thick walls. If the clamshell installation procedure is not performed, depending on wall thickness, wall framing around the rough opening will be revealed when looking inside the vault door.

Tools and Materials Needed for Concrete Anchor Installation:

1. Allen wrench: 7/32"
2. Wrench: 9/16"
3. Level
4. Shim shingles
5. Drill and 1/2" concrete drill bit
6. Hammer
7. Small pry bar (optional)
8. 1/2" concrete wedge anchors (10x)
9. 3M brand high temperature silicone sealant

Custom bolts ordering reference table

Wall thickness (in)	Vault door bolt length needed (in)	Rhino Metals bolt part number	Description for sourcing elsewhere	Qty Needed
8-8.5	2	3678	Button head bolt, .375-16 x 2", fully threaded, hex drive, grade 5, black oxide	15
8.6-9.5	3	4628	Button head bolt, .375-16 x 3", fully threaded, hex drive, grade 5, black oxide	15
9.6-10.5	4	4651	Button head bolt, .375-16 x 4", fully threaded, hex drive, grade 5, black oxide	15
10.6-11.5	5	4629	Button Head Bolt, .375-16 x 5", fully threaded, hex drive, grade 5, black oxide	15
Consult Rhino Metals before ordering a vault door for thicker walls				

Rhino Metals	17 Aug 2021	 RHINO METALS Caldwell, Idaho
		VD8040 Outswing Standard and Reverse Installation Instructions
		Sht 1of3 Rev21B

Vault Door Clamshell Installation Instructions

1. **To avoid being locked out of the vault door room during install, make sure not to spin a vault door manual lock with the vault door closed.**
2. Move the vault door package close to the install room's opening and unpackage the contents.
3. Place the vault door assembly in front of the install room's wall opening and have the front of the vault door face outside the room (but leave enough room so the detachable back frame can be moved inside the install room once detached).
4. **While supporting the vault door's back frame** (to keep the frame from falling once the bolts are removed), use the 7/32" allen wrench to carefully remove the back frame's button head bolts (start with the bolts at the bottom first). Gently place the frame inside the install room.
5. The pieces of tubing that came with the bolts should be discarded at this time (tubing is used for shipping only not install).
6. Slowly and carefully separate the vault door frame from the shipping stand by removing the draw bolts that connect the stand and frame in the the order/process outlined below:
 1. Support the vault door so the door will lean gently against the wall instead of falling forward once the first set of bolts are removed.
 2. Using the 9/16" wrench, carefully remove the top bolt from each side of the shipping stand (afterwards, one bolt should be remaining on both sides of the shipping stand) and lean the vault door frame gently against the wall.
 3. Continue to support the door while removing the last bolt from each side of the shipping stand and gently lower the vault door to the floor.
7. Move the shipping stand pieces out of the way.
8. Have one or two install team members move inside the install room and then have the remaining members move the vault door into the wall opening. A pry bar may be used to help slowly move the door into place.
9. While the outside install team members hold the door in place, have the inside install members use shim shingles to raise and slide the door backwards.
10. Use the shim shingles to adjust the door frame until the bolt holes are aligned properly.
11. Reinstall three or four bolts (finger-tight only) to reattach the back frame. To avoid cross-threading, do not overtighten the bolts.
12. Open the door and install the remaining bolts, leaving all bolts sticking out about 1/4".
13. Use high temperature 3M brand silicone between the frame and the wall.
14. Use high temperature 3M brand silicone between the threshold and the floor (both from outside vault door room and inside vault door room).

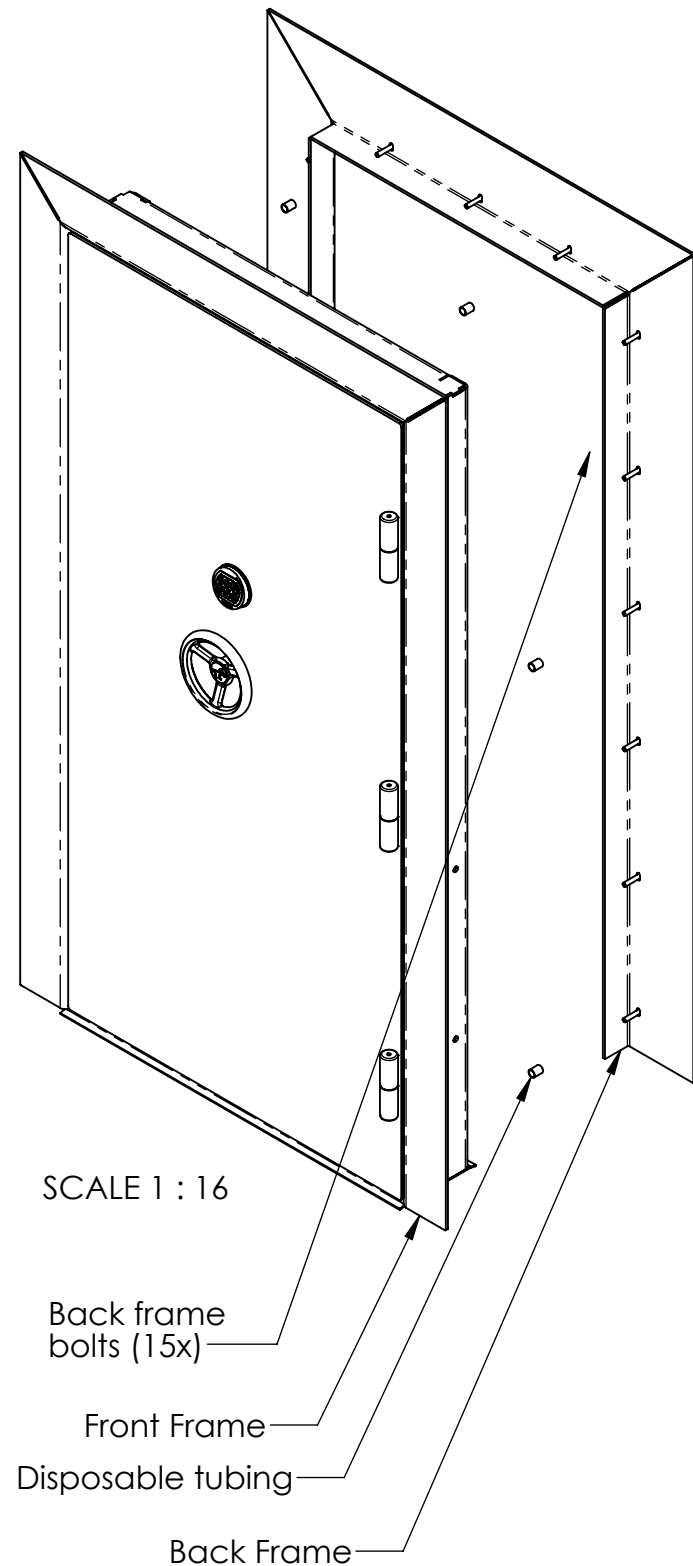

Vault Door Clamshell Leveling Instructions

1. Since the wall may not be plumb, check that the hinge side of the door is vertical. Shim shingles may be used to make any adjustments. If the door is not vertical, the door may swing in/out while not locked into place.
2. Tighten the draw bolts on the hinge side (finger tight).
3. Have the outside install team push firmly against the top and then bottom of the door frame (one at a time). If the frame does not spring back and forth, finish tightening all the draw bolts. Make sure not to over-tighten the bolts. If the door does spring back and forth, shim the doorjamb out until the doorjamb matches the door and test the top and bottom again.
4. Rotate the door handle to fully extend the locking pins. If the vault door was correctly installed, the locking pins should fully extend easily. If the pins are difficult to extend, call your dealer.

Combination Instructions

1. Rhino Metals vault doors with electronic locks allow a custom combination to be chosen. Vault doors with manual (dial) locks have their combination set at the factory.
2. **Before closing and locking your vault door or setting a new combination, test your combination with the door open at least four times.** Without the correct combination, once locked, the vault door will not be able to be opened from the outside without additional assistance.
3. Avoid storing the combination near the vault door. Instead, store the combination in a secure place unlikely to be found by potential criminals.
4. For more detailed lock information (including warranty) refer to your vault door owner's manual.

Troubleshooting

1. If there are any issues with your vault door installation, please contact your dealer first.
2. If your dealer is unable to assist, please contact Rhino Metals technical support (208) 454-5545.

	Rhino Metals	17 Aug 2021	 RHINO METALS Caldwell, Idaho
			VD8040 Outswing Standard and Reverse Installation Instructions
			Sht 2of3 Rev21B

Vault Door Concrete Anchor Installation Instructions

1. **To avoid being locked out of the vault door room during install, make sure not to spin a vault door manual lock with the vault door closed.**
2. Move the vault door package close to the install room's opening and unpackage the contents.
3. Place the vault door assembly in front of the install room's wall opening and have the front of the vault door face outside the room (but, if installing the back frame is desired for aesthetics, leave enough room so the detachable back frame can be moved inside the install room once detached).
4. **While supporting the vault door's back frame** (to keep the frame from falling once the bolts are removed), use the 7/32" allen wrench to carefully remove the back frame's button head bolts (start with the bolts at the bottom first). Gently place the frame inside the install room (if reattachment is desired for aesthetics).
5. The pieces of tubing that came with the bolts should be discarded at this time (tubing is used for shipping only not install).
6. Slowly and carefully separate the vault door frame from the shipping stand by removing the draw bolts that connect the stand and frame in the the order/process outlined below:
 1. Support the vault door so the door will lean gently against the wall instead of falling forward once the first set of bolts are removed.
 2. Using the 9/16" wrench, carefully remove the top bolt from each side of the shipping stand (afterwards, one bolt should be remaining on both sides of the shipping stand) and lean the vault door frame gently against the wall.
 3. Continue to support the door while removing the last bolt from each side of the shipping stand and gently lower the vault door to the floor.
7. Use high temperature 3M brand silicone around the wall's door opening where the vault door outer frame will rest once installed.
8. Have one or two install team members move inside the install room and then have the remaining members move the vault door into the wall opening. A pry bar may be used to help slowly move the door into place.
9. While the outside install team members hold the door in place, have the inside install members use shim shingles to raise and slide the door backwards.
10. Use a 1/2" concrete drill bit to drill through the top and bottom bolt holes on the left and right side of the frame. A depth of at least 4in into the concrete is recommended.
11. Tap four 1/2" wedge anchors into the concrete holes.
12. Square the door frame by loosening and tightening the four set anchors at the top and bottom of each side of the frame.
13. Drill remaining concrete holes and set remaining 1/2" wedge anchors (do not forget top holes). Tighten evenly around the frame while opening and closing the door multiple times to ensure the frame is not pulled out of square.
14. Follow steps 11 and 12 on page two for reinstalling the optional back frame.
15. Use high temperature 3M brand silicone between the frame and the wall.
16. Use high temperature 3M brand silicone between the threshold and the floor (both from outside vault door room and inside vault door room unless the back frame has not been installed).

Combination instructions

1. Rhino Metals vault doors with electronic locks allow a custom combination to be chosen. Vault doors with manual (dial) locks have their combination set at the factory.
2. **Before closing and locking your vault door or setting a new combination**, test your combination with the door open at least four times. Without the correct combination, once locked, the vault door will not be able to be opened from the outside without additional assistance.
3. Avoid storing the combination near the vault door. Instead, store the combination in a secure place unlikely to be found by potential criminals.
4. For more detailed lock information (including warranty) refer to your vault door owner's manual.

Troubleshooting

1. If there are any issues with your vault door installation, please contact your installer first.
2. If your dealer is unable to assist, please contact Rhino Metals technical support (208) 454-5545.

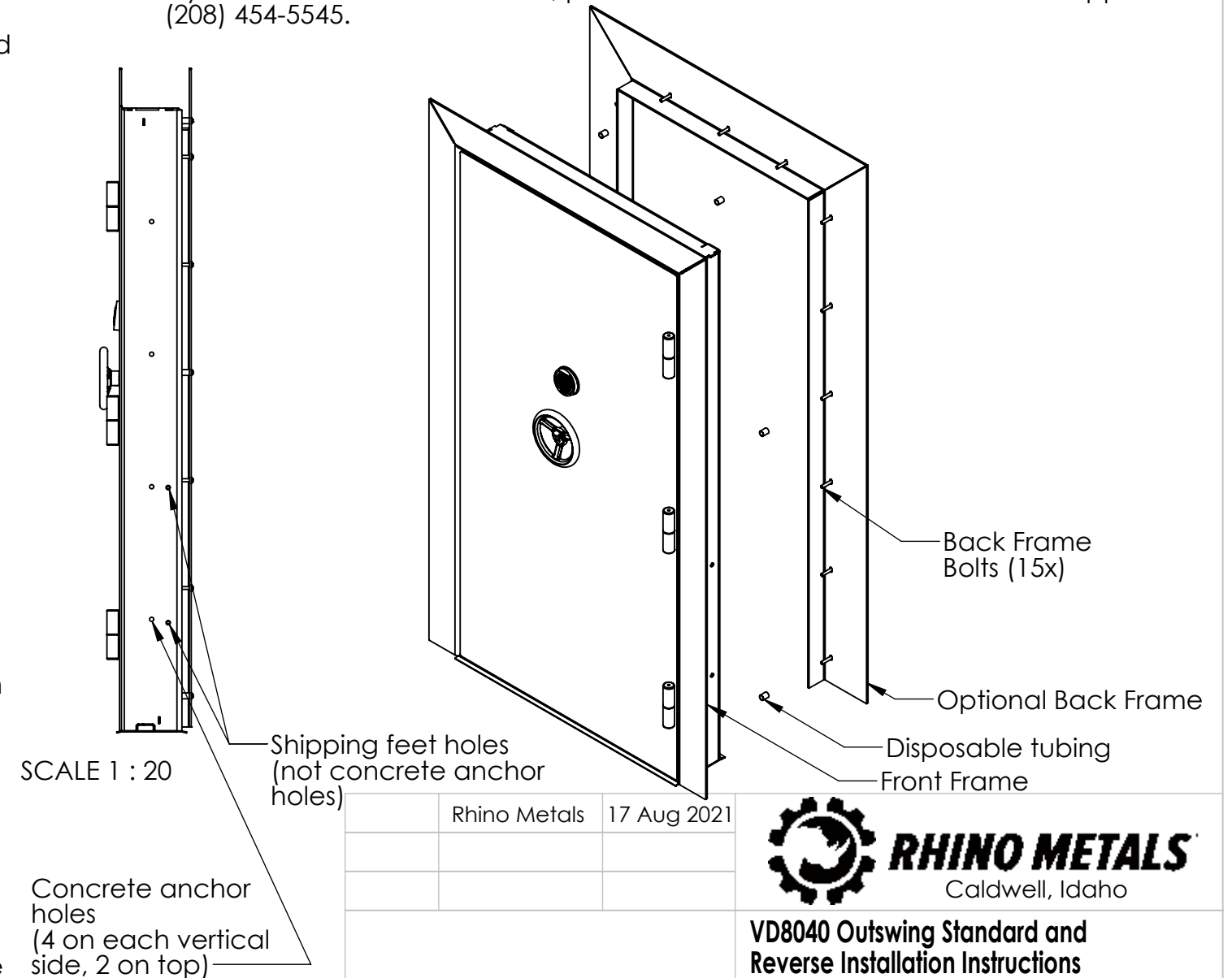

Rhino Metals 17 Aug 2021



VD8040 Outswing Standard and Reverse Installation Instructions